

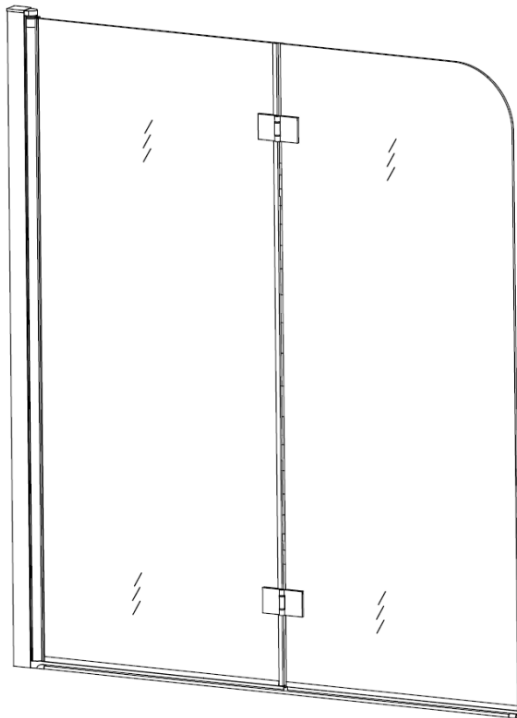

DUROVIN
BATHROOMS

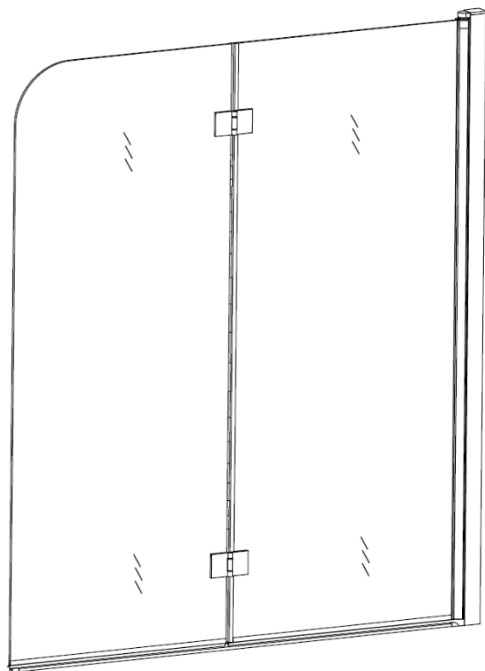

OR



DWA140-8N/8SN (L/R)

Installation

Tools Required

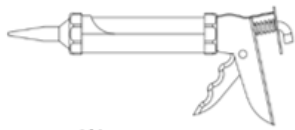

Silicone Gun

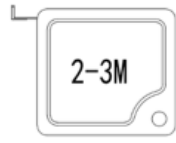

Tape Measure



Scissors

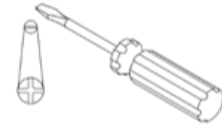

Philips Screwdriver



Hammer



Allen Keys

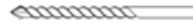

Drill Bit



Pencil



Power Drill



Level

Two people required. We recommend that a technically competent installer should undertake this installation.

Be sure you have all included parts and tools required before beginning installation and that you have plenty of space for assembly.

If you have ordered this shower enclosure with one of our shower trays, **please note** that tiling should be done before the shower tray is installed. This is so that the shower tray can be pushed up against the tiles and sealed with silicone.

PRE-INSTALLATION AND TECHNICAL REQUIREMENTS

- All dimensions are shown in millimetres, except where otherwise indicated.
- Ensure that the enclosure set is fitted to a level floor and vertical wall surface.
- This instruction manual is applicable for both pre-tiled wall and plain walls.
- The wall fixings included with this product are suitable for solid walls only. Plasterboard or stud walls may require specialist fixings (not supplied).
- Due to the possibility of residual spray, the area around the outside of the shower tray should be tiled, or made otherwise water resistant.

IMPORTANT SAFETY NOTES

- Under no circumstances should you attempt to drill through the glass, damage or injury may occur
- Please handle all glass with care, avoiding knocks and shock loading to all sides and edges. Safety glass cannot be reworked.
- Care should be taken when drilling into walls to avoid hidden pipes or electrical cables.

Included Parts

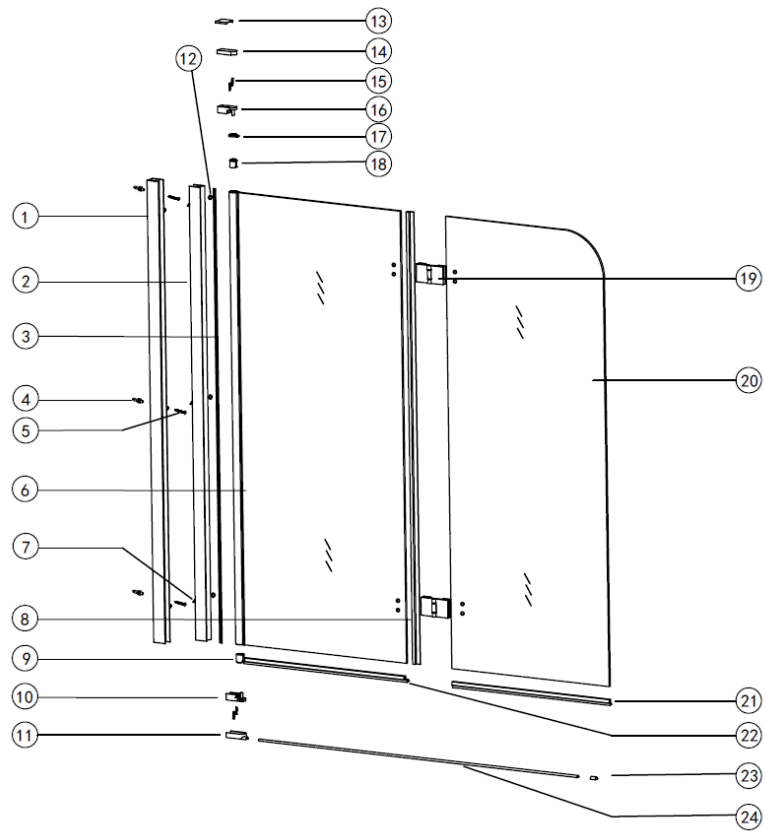

Ref	Illustrations	Description	Qty	Ref	Illustrations	Description	Qty
1		Wall Profile	1	13		Cap	1
2		Aluminium profile	1	14		Cap	1
3		Seal	1	15	ST3.5*30	Screws	4
4	$\phi 6$	Wall Plugs	3	16		Top Fixing Piece	1
5	ST4*30	Screws	3	17		Cap	1
6		Glass	1	18		Top Pivot Pin	1
7	ST4*10	Screws	3	19		Hinges	2
8		Seal	1	20		Glass	1
9		Bottom Pivot Pin	1	21		Bottom Seal	1
10		Bottom Fixing Piece	1	22		Bottom Seal	1
11		Fixing Piece	1	23		End Plate	1
12		Caps	3	24		Weather Bar	1

Install on the LEFT

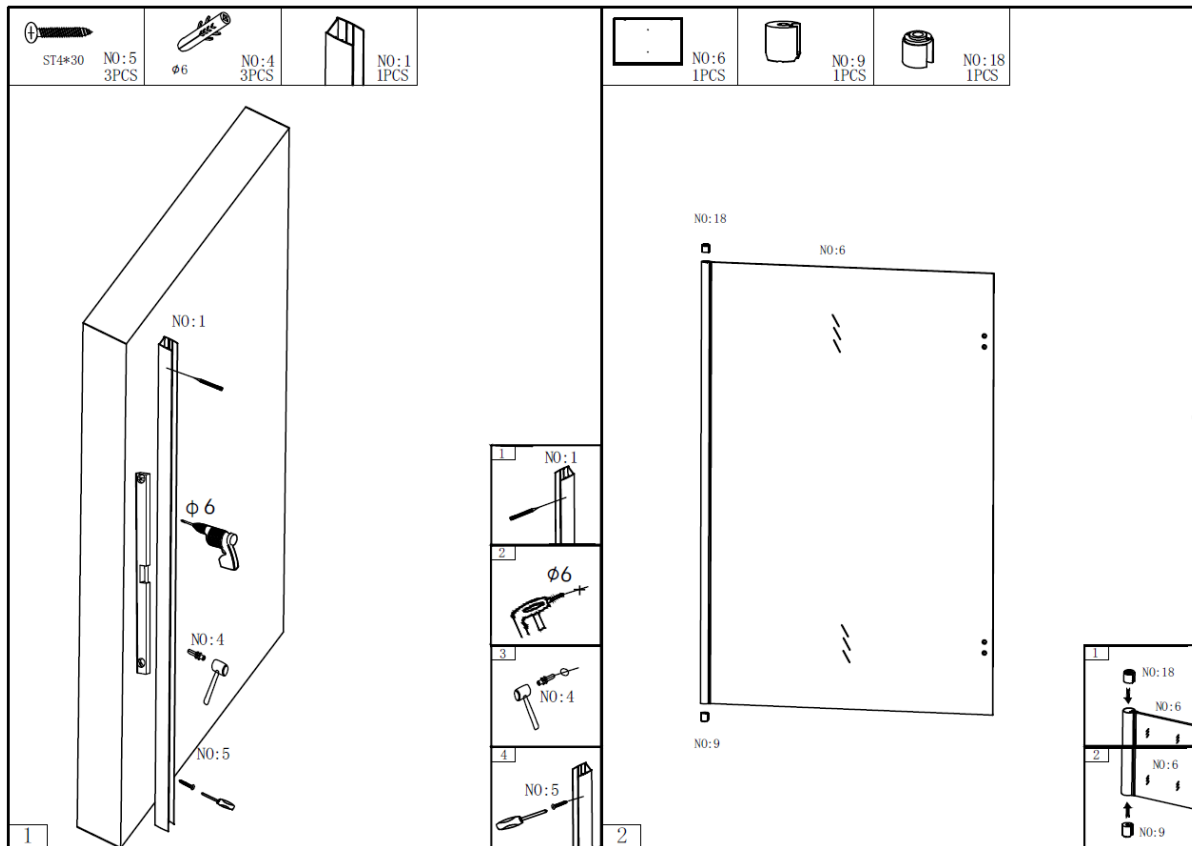

1. Check with a spirit level that the aluminium wall profile is level with the wall.
2. Mark with a pencil where holes will be drilled.
3. Drill holes and insert wall plugs.
4. Screw the aluminium profile onto the wall.
5. Install the top and bottom Pivot Pin

Important Reminder: As required for installation on the left or right side.

Follow the sticker guide on the Glass Make sure the 'NANO' stickers on both glass panels are facing the same way

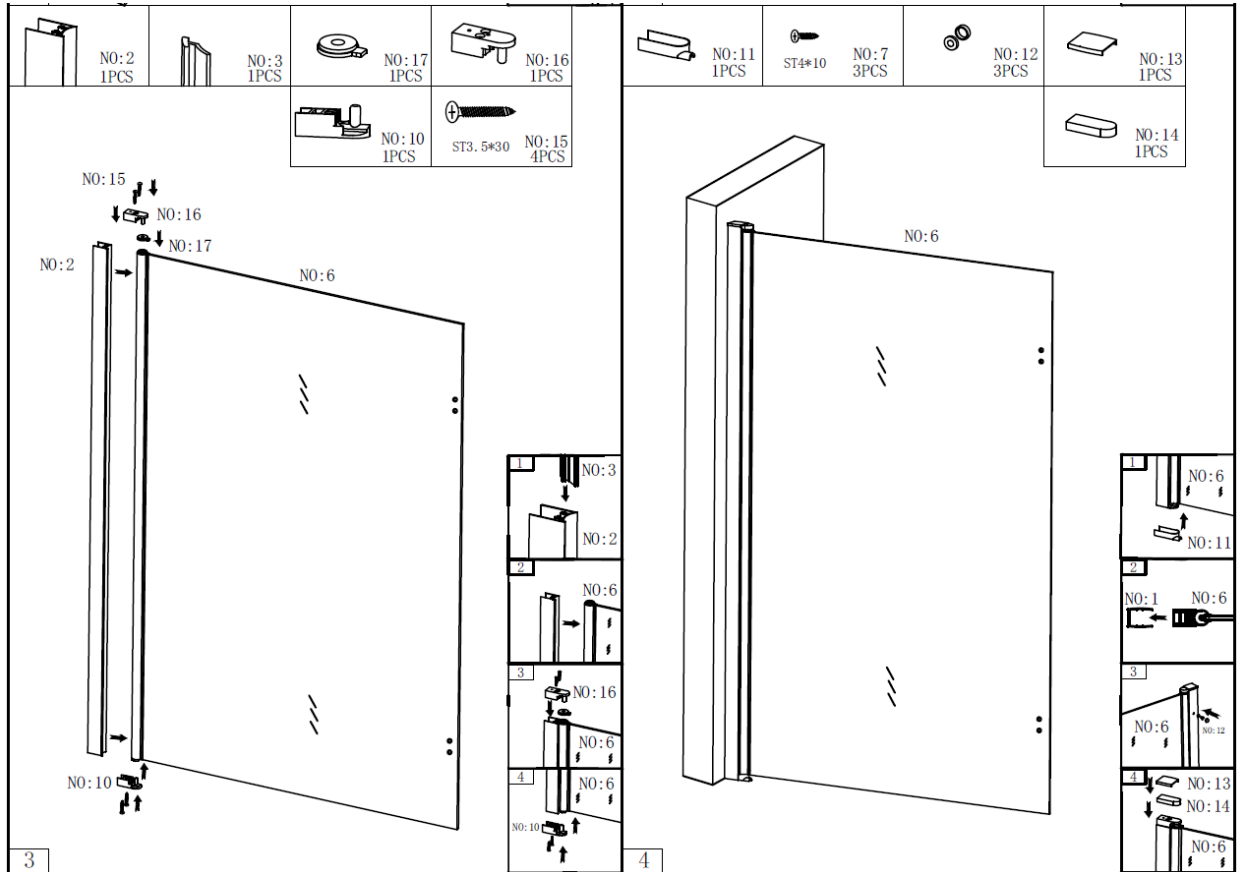

6. Install the aluminium and seal to the glass with fixing piece
7. Insert the glass panels into the aluminium wall profile
8. Install the screws and attach the cover.

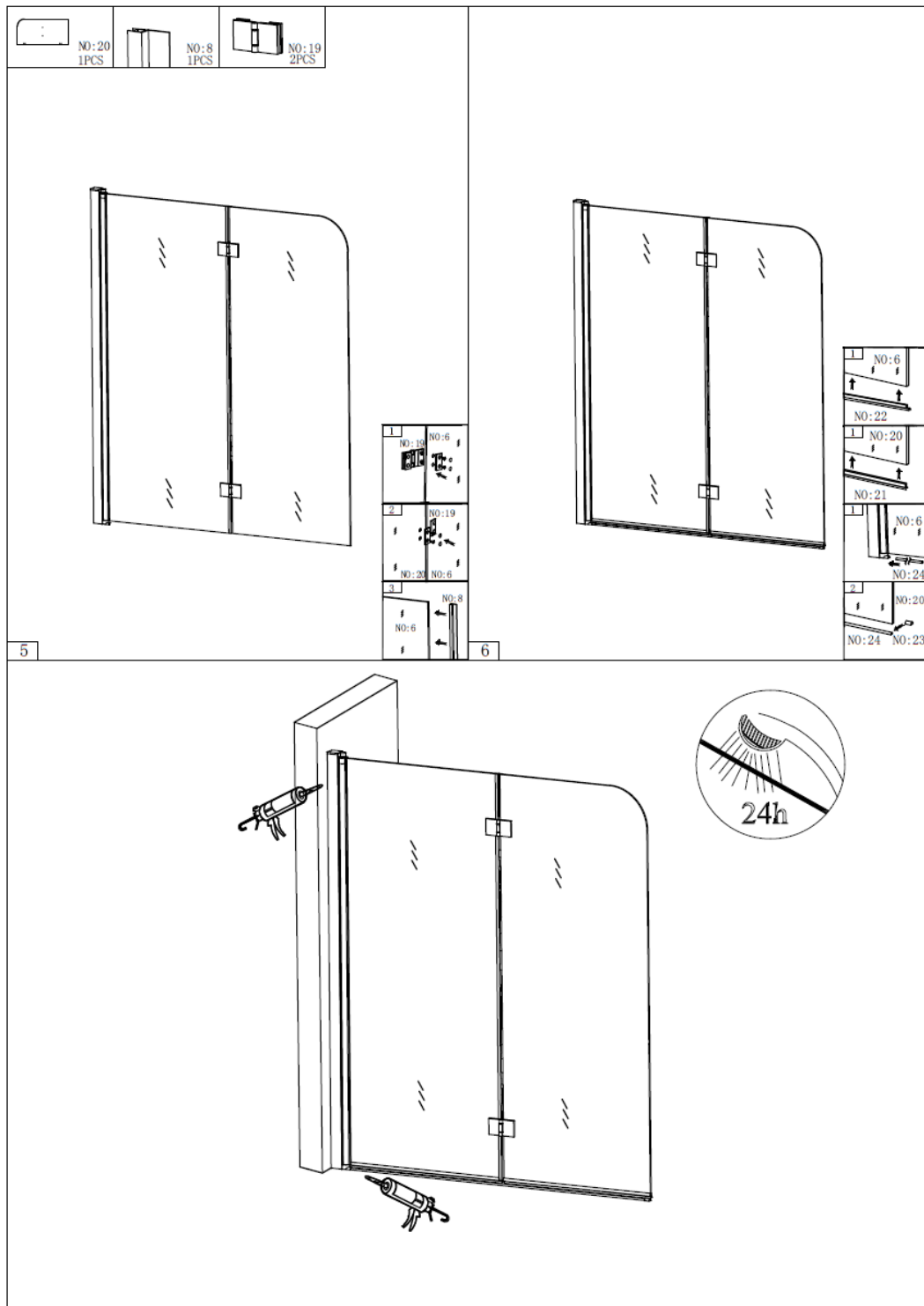

9. Install the hinges and seal
10. Install the weather bar
11. Install the bottom seals
12. Silicone and allow to dry for 24 hours.

Install on the RIGHT

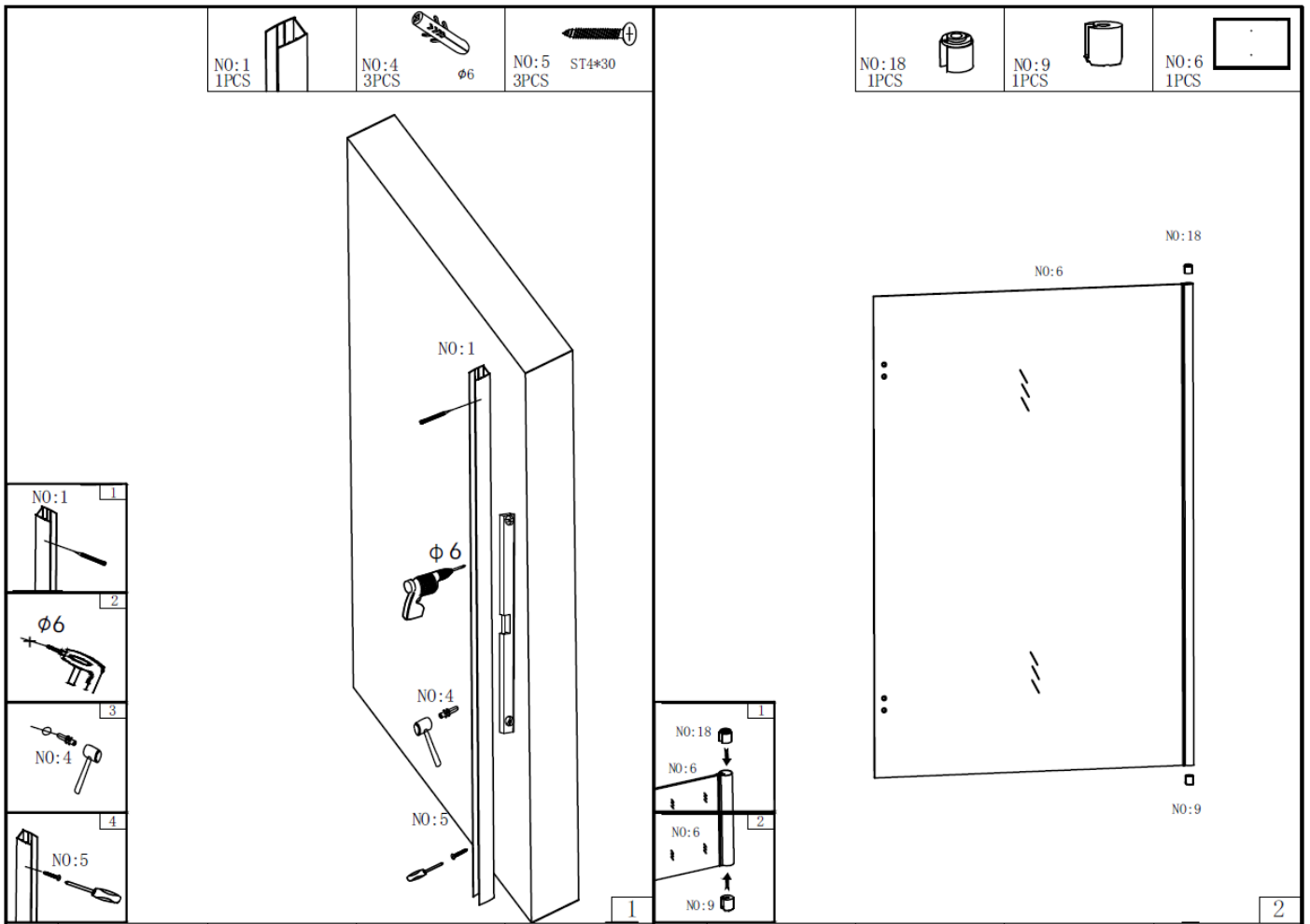

1. Check with a spirit level that the aluminium wall profile is level with the wall.
2. Mark with a pencil where holes will be drilled.
3. Drill holes and insert wall plugs.
4. Screw the aluminium profile onto the wall.
5. Install the top and bottom Pivot Pin

Important Reminder: As required for installation on the left or right side.

Follow the sticker guide on the Glass Make sure the 'NANO' stickers on both glass panels are facing the same way

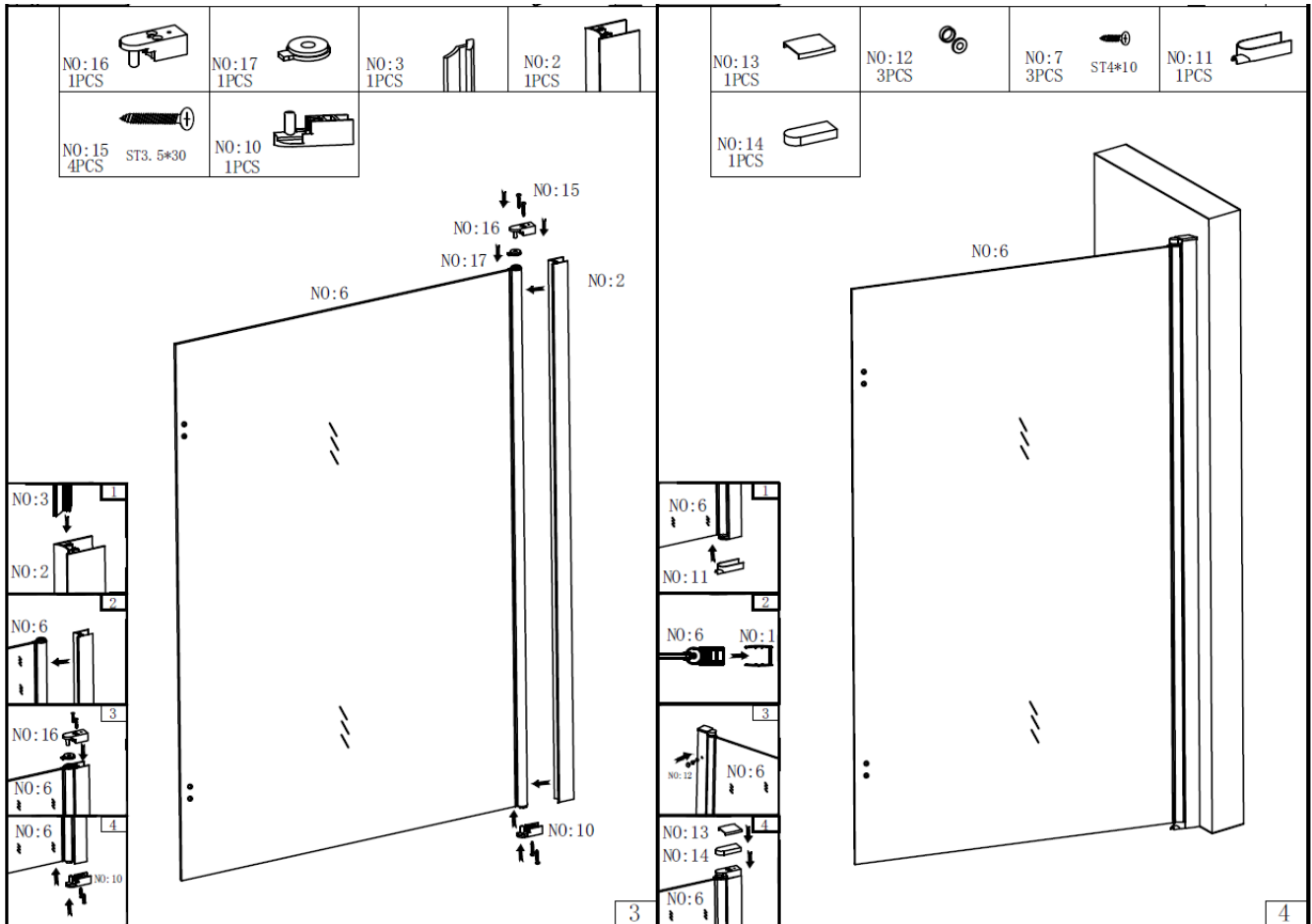

6. Install the aluminium and seal to the glass with fixing piece
7. Insert the glass panels into the aluminium wall profile
8. Install the screws and attach the cover.

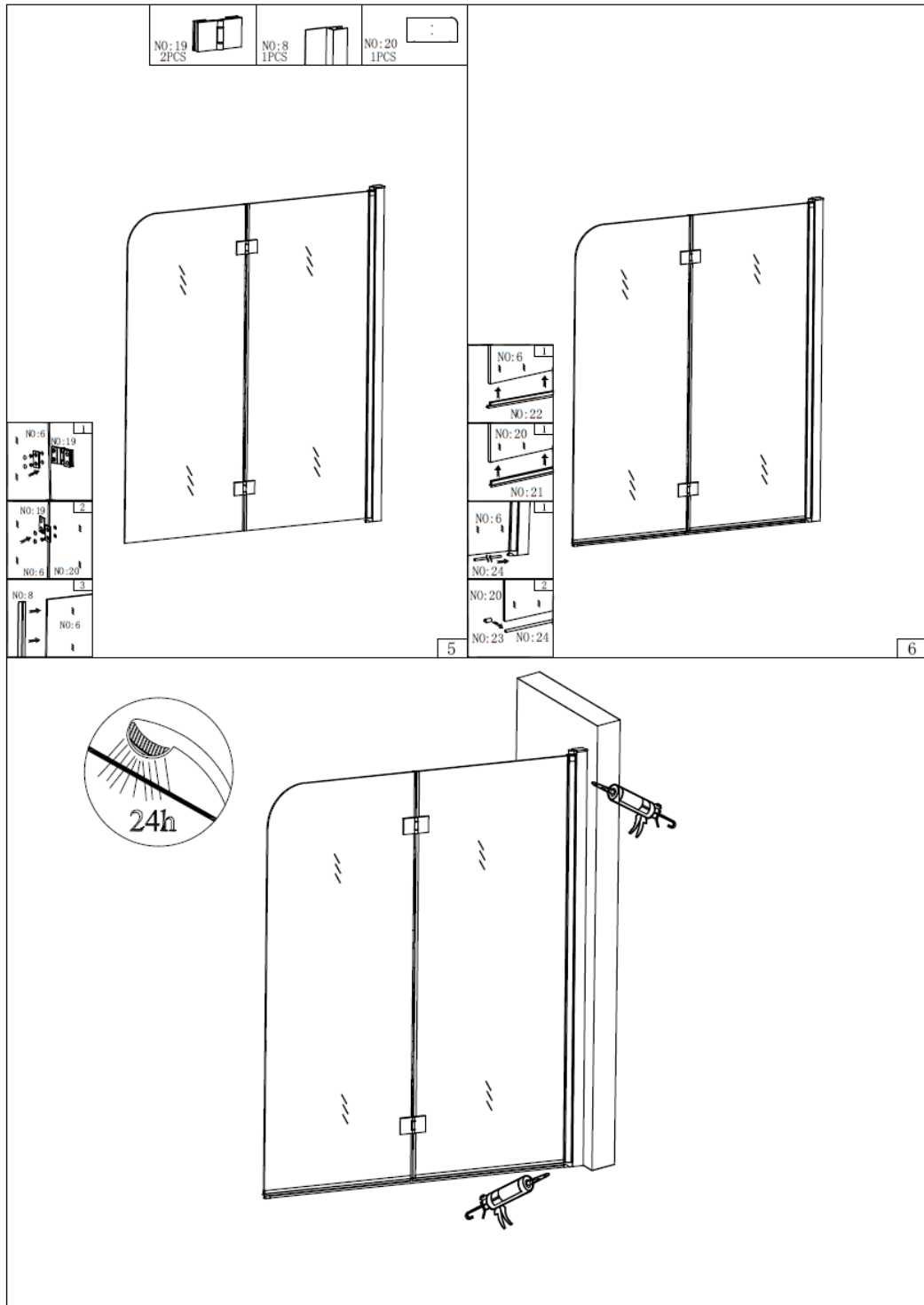

9. Install the hinges and seal
10. Install the weather bar
11. Install the bottom seals
12. Silicone and allow to dry for 24 hours.